

A	B	C			D	E
1	B206-108	2354	565	16	1	2/2
2	B206-109	2354	565	16	1	2/2
3	B206-338	718	560	16	1	1/2
4	B206-339	718	560	16	1	1/2
5	B206-401	718	65	16	1	1/2
6	B206-901	2284	740	2,5	1	2/2
7	B206-340	718	560	16	1	1/2
8	B206-342	717	560	16	2	1/2
9	dr-713	713	22	15	2	1/2
Фурнитура / Accesories					1	1/2

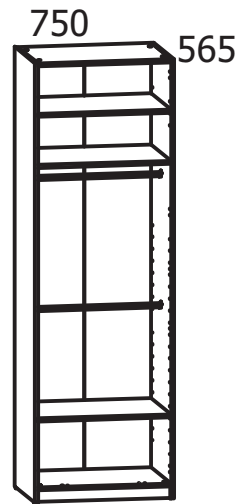

2359

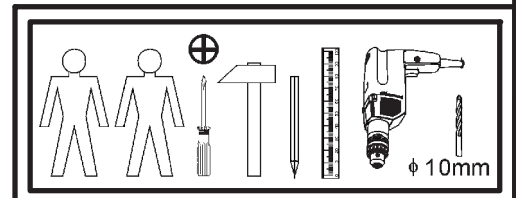
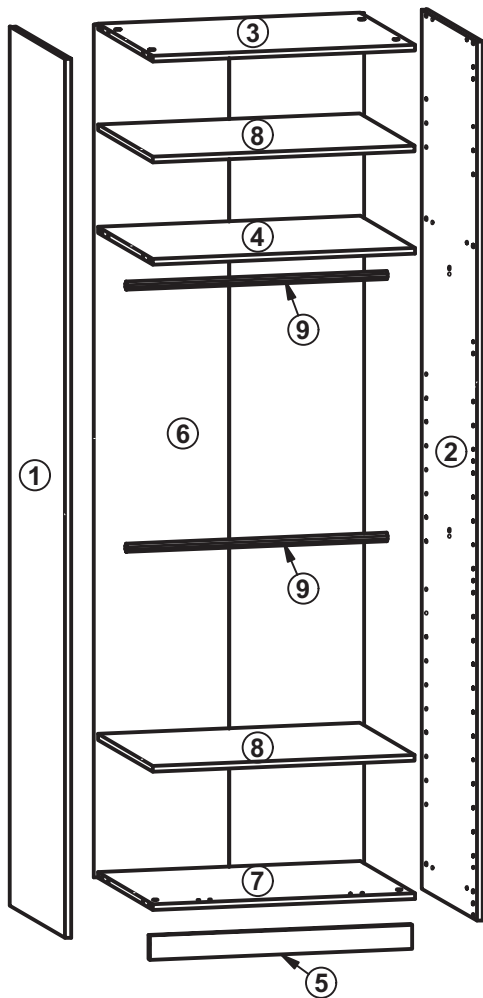

k75/1 Ø6x13 mm	x2n1 Ø2.9x16mm	x4	z15	x1f1	x16	r42	x12	r1	x12	s2	x4	d28	x8		
e3 Ø3,5x15mm	x8	p55	x50	k1	x4	p21	x6	n14	x1	f35	x1	p17	x1	s59	x110
p51	x4														

1

<p>Ø3,5x15mm p51</p>	<p>x4 n1</p>	<p>20/11 x4 r42</p>	<p>Ø15x12 mm #16 x12 r1</p>	<p>Ø8x30 mm x12 f1</p>	<p>x16</p>
--------------------------	--------------	-------------------------	---------------------------------	----------------------------	------------

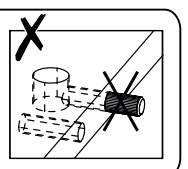
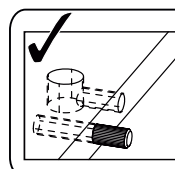
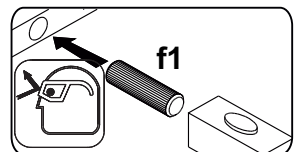
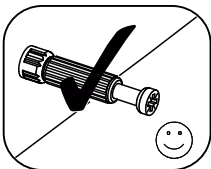
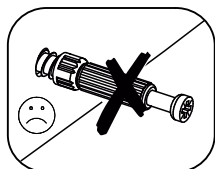
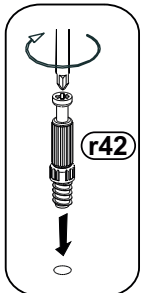
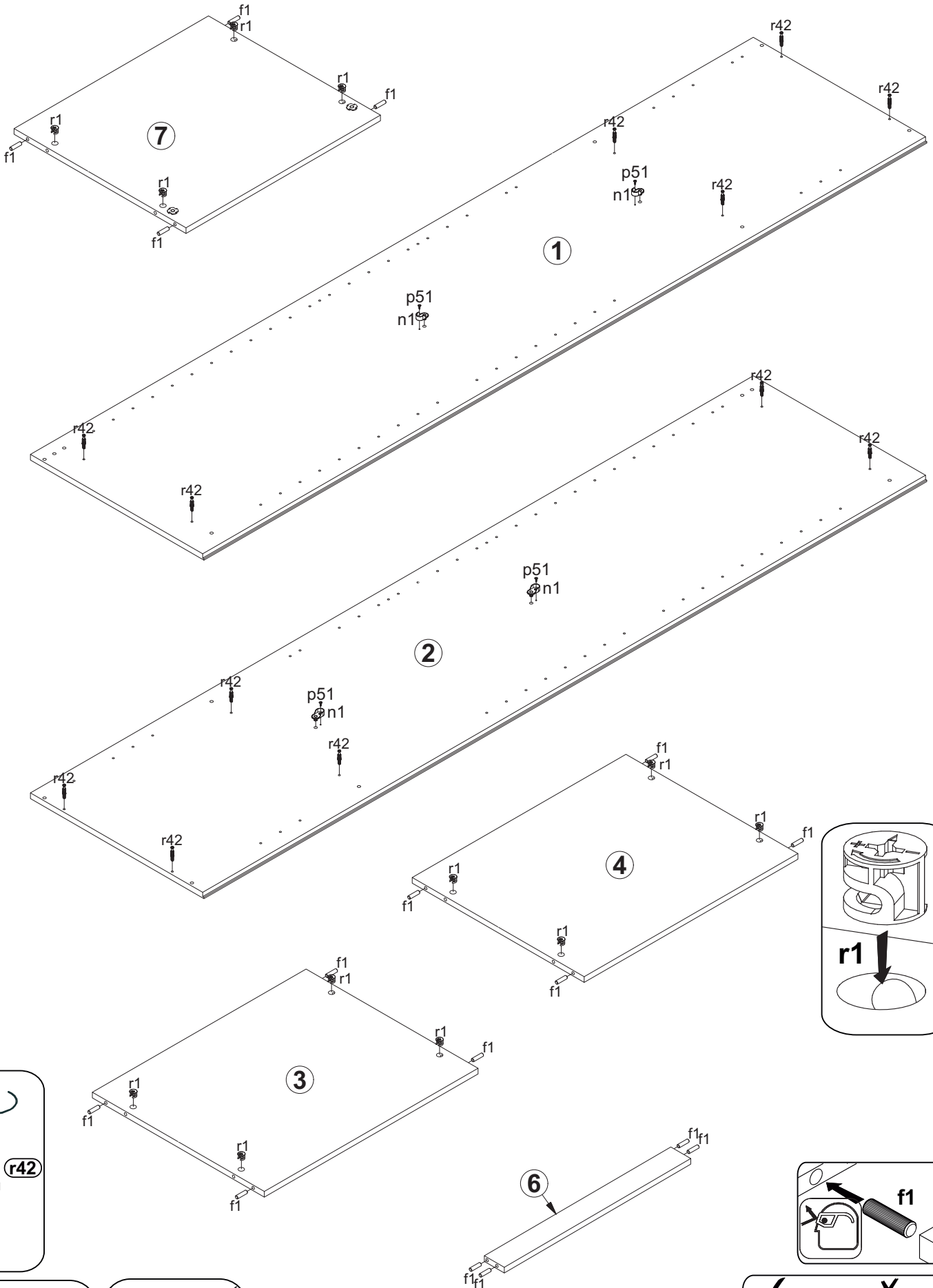

2

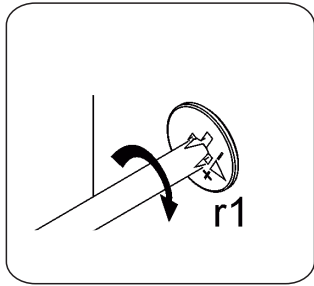
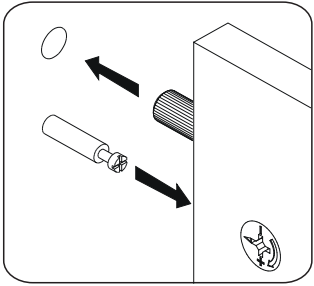
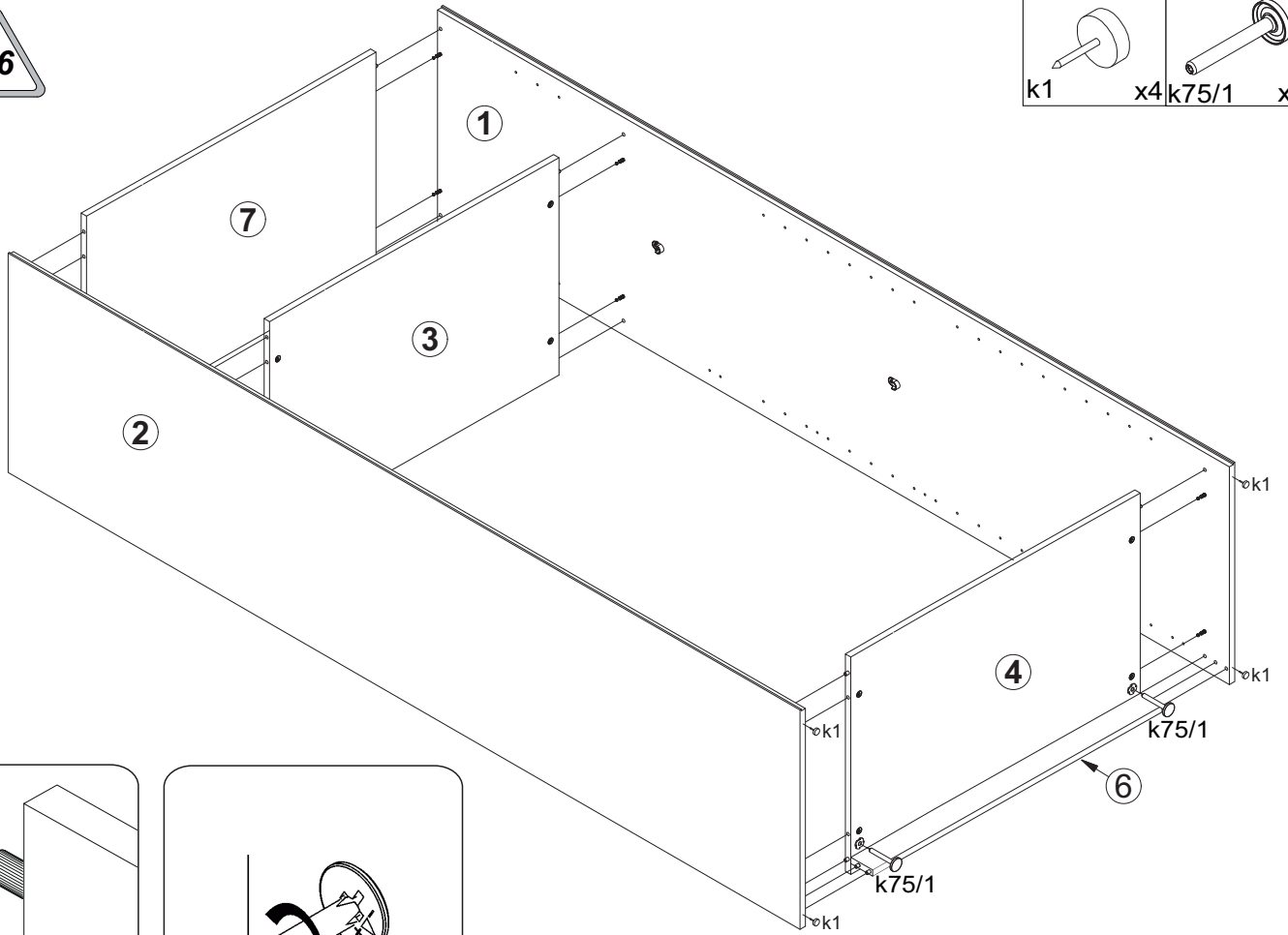
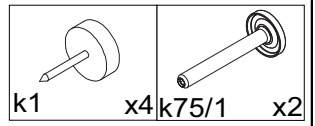

3

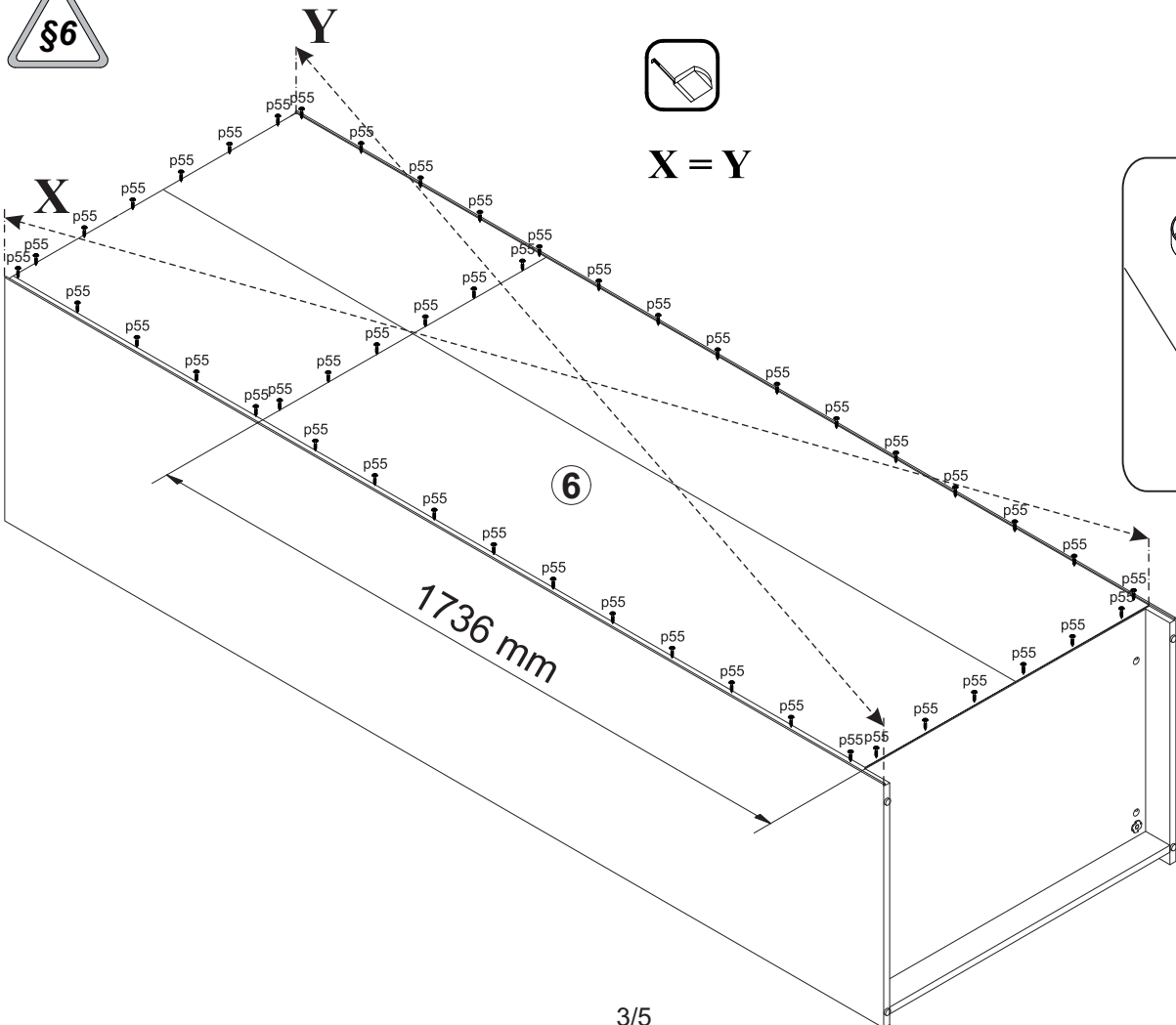
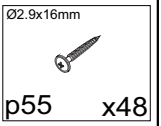

X = Y

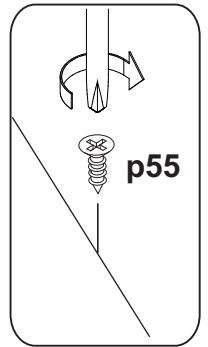

4



A n14

B Ø10

C f35

D p55
n14/2

E p17
n14/2

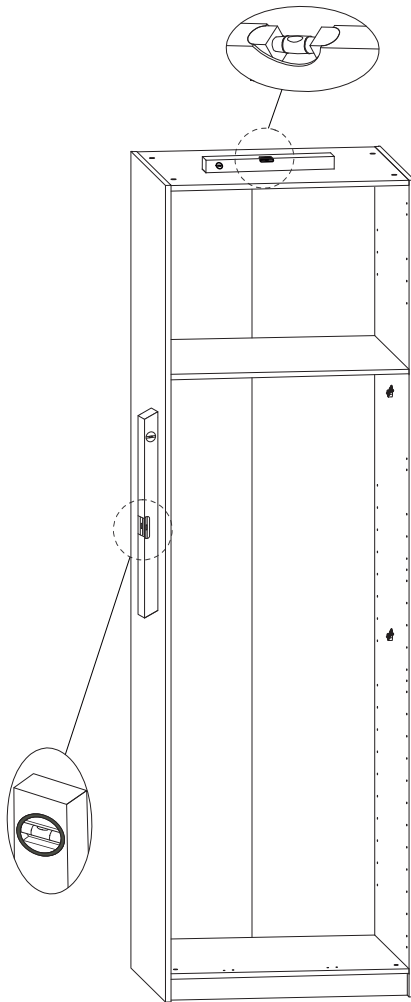

φ5x60 mm 	Ø2.9x16mm 		
p17 x1	p55 x2	n14 x1	x1
Ø16 			
s2 x4	z15 x1	f35 x1	x1

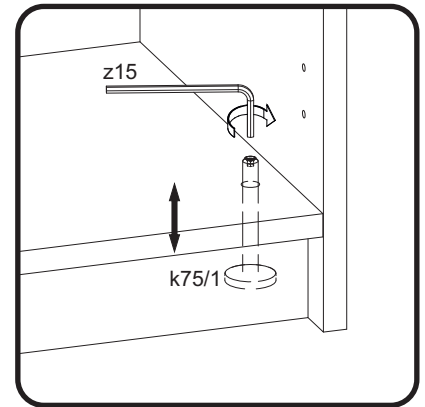
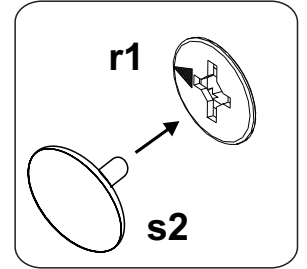

5

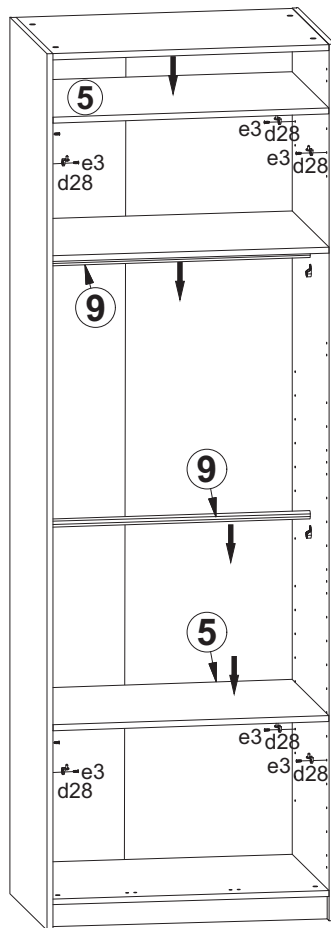
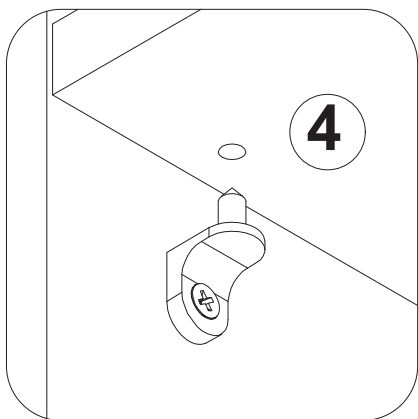
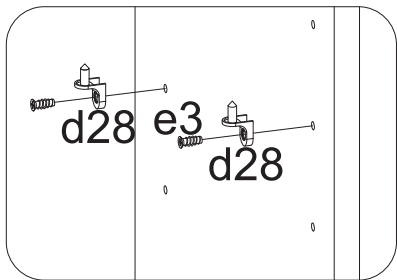

	Ø4,0x30 mm 	Ø6x13 mm 	
s59 x110	p21 x6	e3 x8	d28 x8

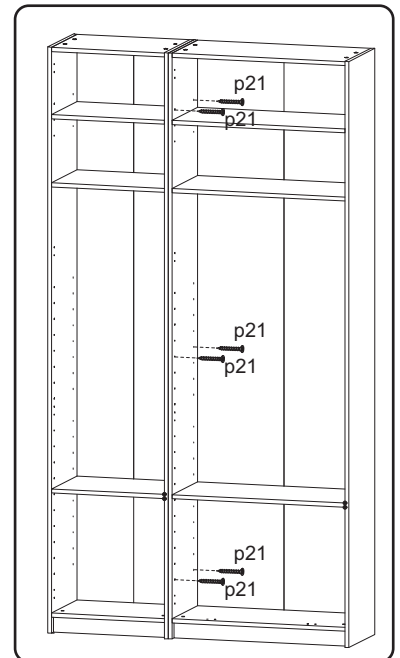
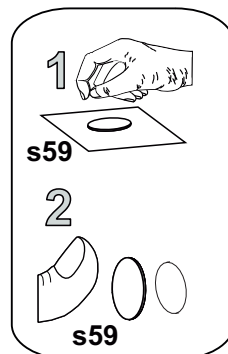
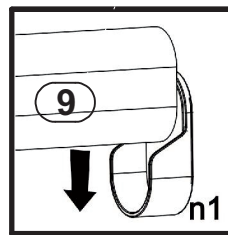

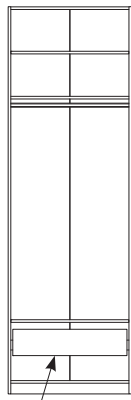

Ящик
SZU/75/56

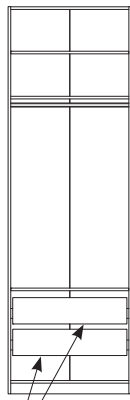

Ящик
SZU/75/56 x2

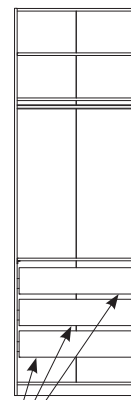

Ящик
SZU/75/56 x3

Щит дистанционный DN/25

Щит дистанционный DN/25

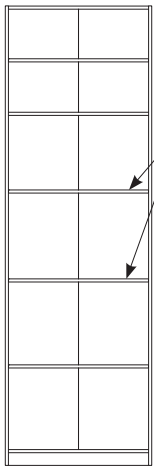

Комплект полок
POL/75/56

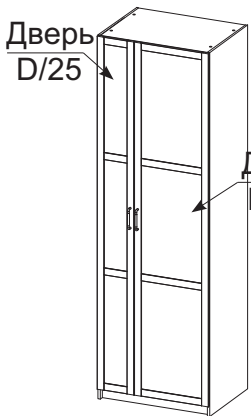
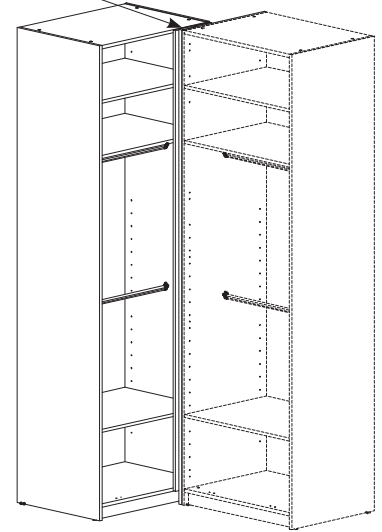
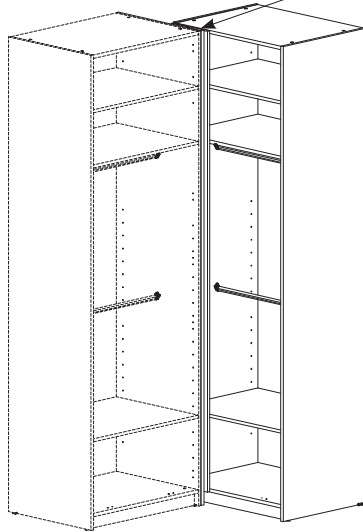

Дверь
D/25

Дверь
D/50



Дверь
D/25

Дверь
с зеркалом
L/50

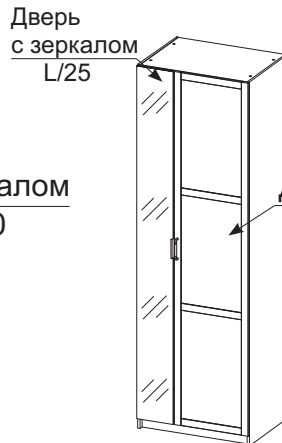

Дверь
с зеркалом
L/25

Дверь
D/50

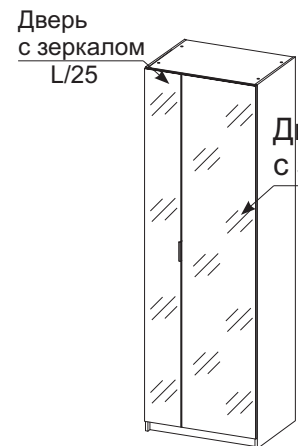

Дверь
с зеркалом
L/25

Дверь
с зеркалом
L/50



Дверь
D/50

Дверь
D/25



Дверь
с зеркалом
L/50

Дверь
D/25



Дверь
D/50

Дверь
с зеркалом
L/25



Дверь
с зеркалом
L/50

Дверь
с зеркалом
L/25