

RUS

Инструкция по сборке

ВНИМАНИЕ! Перед началом сборки изделия просим ознакомиться с инструкцией по сборке, а также с рекомендациями по эксплуатации и обслуживанию.

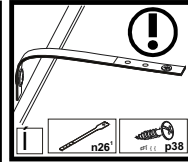
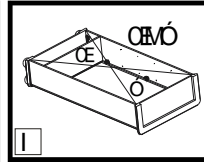
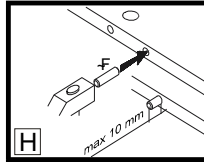
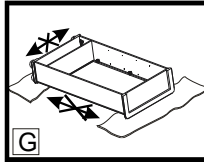
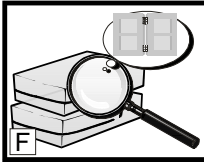

ВНИМАНИЕ! Перед началом сборки изделия просим ознакомиться с инструкцией по сборке, а также с рекомендациями по эксплуатации и обслуживанию.

Пояснения / описание возможных указаний, используемых в инструкции по сборке

§1	О	О	О	О	О	§13
----	---	---	---	---	---	-----

§2 Фурнитура находится в пакке с маркировкой «ФУРНИТУРА».

§14

§3

§15

§4

ВНИМАНИЕ!

§16

§5

ВНИМАНИЕ!

§18

§6

ВНИМАНИЕ!

§20

§7

ВНИМАНИЕ!

§21

§8

§9

ВНИМАНИЕ!

§22

§10

ВНИМАНИЕ!

§23

§11

§12

REG/50,REG/75,REG/100,SZF/50,SZF/75,SZF/100,SZFN.

Рекомендации по эксплуатации и обслуживанию

ВНИМАНИЕ! Перед началом эксплуатации изделия просим ознакомиться с рекомендациями по эксплуатации и обслуживанию.

ЗАПРЕЩАЕТСЯ

Гарантии изготовителя

Гарантия на изделие предоставляется на срок 5 лет с даты изготовления.

Дата

Штамп ОТК

ИООО "БРВ-Брест", ул. Мухоморова, 10, г. Брест, Республика Беларусь

Furniture Assembly

Note: Before starting to assemble furniture, please read all the Furniture Assembly Instructions including the rules for maintenance and use. Follow the sequence of individual assembly stages according to the paragraphs  provided in the General Rules for Furniture Assembly.

KEEP THESE INSTRUCTIONS FOR THE DURATION OF FURNITURE USE.



1. **NOTE!** Do not proceed with assembly if any components are defective or damaged.
2. Place the components on a soft, clean surface, e.g. a towel or blanket, during assembly. Do not assemble furniture on rags, carpets, etc.
3. Drive the dowel pins f1 into the 8mm diameter holes, located on components' edges. Leave the cam bolt holes free. Any pin that sticks out by more than 10mm needs to be taken out, replaced and shortened as it may damage the side wall during assembly.
4. Make sure that the diagonals are of equal length before attaching the back wall.
5. **NOTE!** Safety strap. Install according to instructions. Improperly secured furniture may break free and fall during use.
6. Dear Customer, in case of complaints please quote the code number provided on the first page of the Assembly Instructions. Report all comments and complaints where you purchased the furniture. If possible, provide a label of defective product indicating the packing date and the packer.



Explanations / Possible notes used in the Assembly Instructions:

	Component symbol	Code	Dimensions [mm]	Quantity[pcs]	Pack
	A	B	C	D	E

 The first stage of the assembly involves fitting the components with the proper accessories as specified on the drawings below.

 The symbol  denotes places where special caution is required during assembly.

 Set screw adjusts cabinet flap door opening (tighten the screw for the cabinet flap door to fall more freely).

 **NOTE!! Lack of for improper adjustment poses risk of flap door falling freely.**

NOTE!!

Attach unit to wall when completely assembled. Improperly attached furniture may break free and fall while being mounted or used. The unit may only be attached to the wall by a qualified person. Check that the wall is suitable for having furniture attached to it before hand. Choose a suitable anchor bolt and check the strength and quality of the attachment.

 **NOTE!!**
Place the top unit on the base unit then join them using connector plate n52 and screws p25. The unit may break free and fall during use if this instruction is not followed.

 Assemble the unit according to the drawings below using the specified connectors and/or joints.

 **ATTENTION!** The operation must be carried out very carefully in order to damage the parts of the product.

 Apply glue y1 into the holes of the depicted component, attach it and wait for the glue to dry.

 Clean the glued area thoroughly.

 Adjustment

 Adjustment

 **NOTE!!** Handle glass components with extra caution so as not to cut yourself or damage or break the components.

 Drill holes according to drawings. During this operation take special care not to cut yourself or damage the component!

 Tighten the screws e8 so they do not project over the rim.

 Option

 Place the insert upside down onto the frame in place designed for that component using the unfolded top unit.

 The recommended size of the mattress.

 Connect the adjoining units using VHS connecting screws.

NOTE!!

 Use security tape as this is essential to ensure the safety of those who use your furniture.

 The door may be installed either on the left or the right side of the unit.

 **NOTE!! Bed unit and flap have a tendency to slam when closing. There is a risk of injury.**

 Apply masking strip/unit in visible places.

 **NOTE!!** Furniture may break free and fall if not used with caution.

 **NOTE!!** High gloss fronts are covered with a protective film which is to be removed once the component has been hung up. The surface of these fronts cannot be cleaned until least 4 weeks after removing the protective film.



Elements of accessories, designed for self-purchase in specialized stores.

Furniture Use and Maintenance



1. Furniture units must be placed on a level surface and levelled.
2. Check the condition of the cam pins while the furniture is in use. Tighten if necessary.
3. **NOTE!! Do not climb on furniture.**
4. Furniture must be placed in dry rooms, with working ventilation, and at least 1 m from active heat sources. The rooms must be protected against detrimental weather conditions (sunlight, rain, etc.).
5. **NOTE!! Placing excessive loads on furniture is dangerous to users and may cause permanent damage.**
6. Furniture must be moved by being lifted it with no load on it. Note: shifting or dragging furniture may cause permanent damage. When moving, hold the vertical elements of the unit, i.e. the sides and legs. Do not grab the horizontal elements, e.g. structural shelves or drawers, as these are prone to damage.
7. Clean furniture using a damp cloth or paper towel.

A	B	C			D	E
1	B206-003	2284	496	16	1	1/2
-	Фурнитура / Accesories				1	2/2

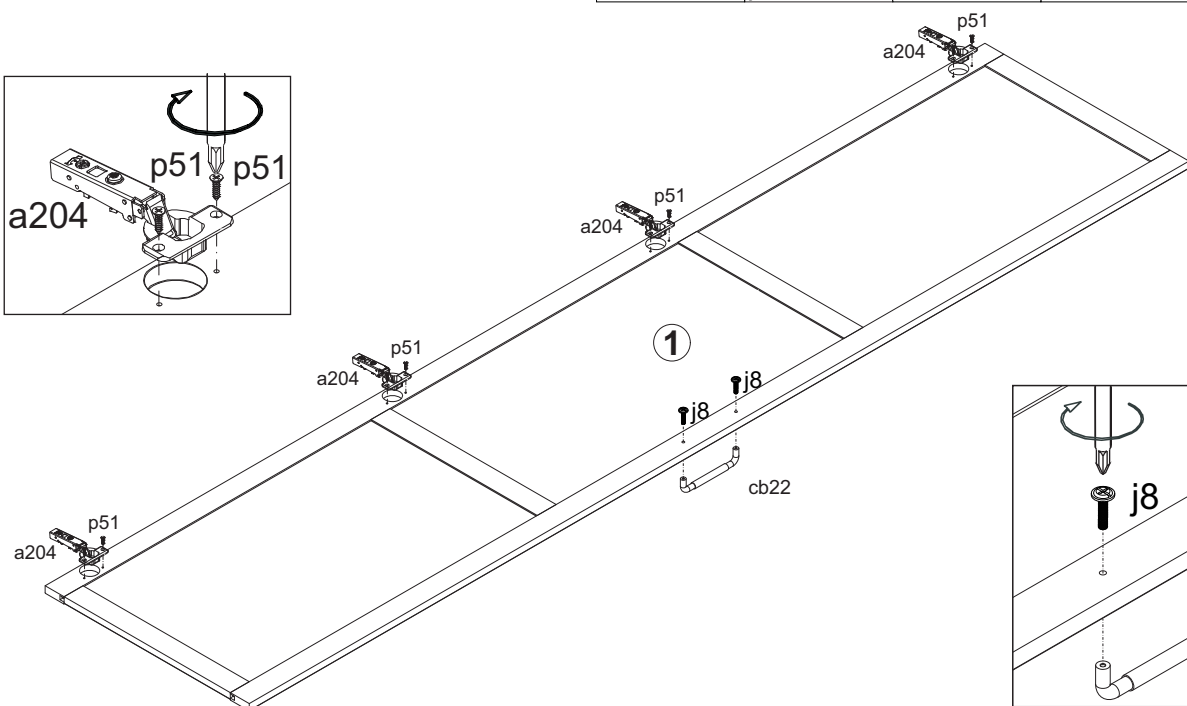
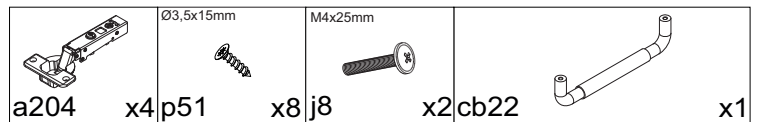
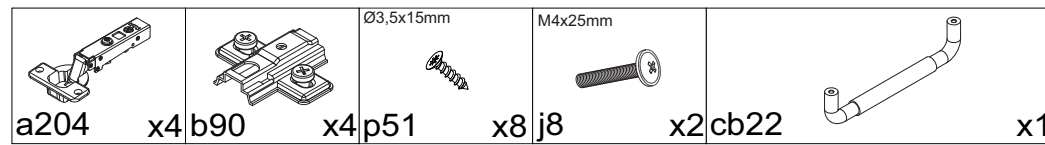
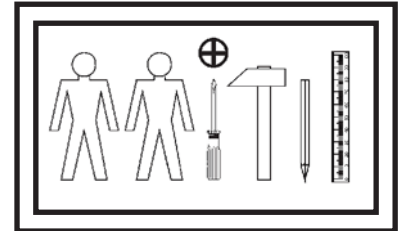
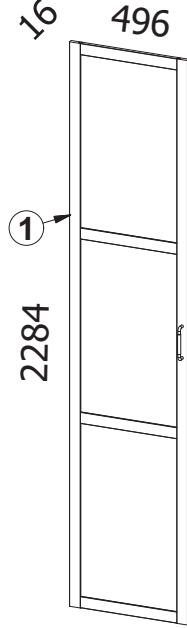
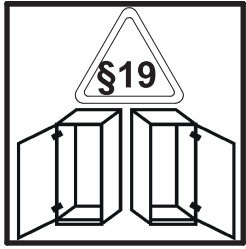

2L

b90 x4

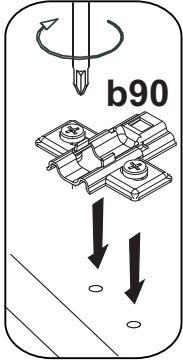
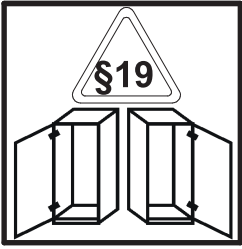

1

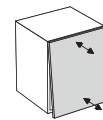
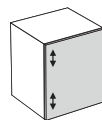
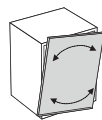
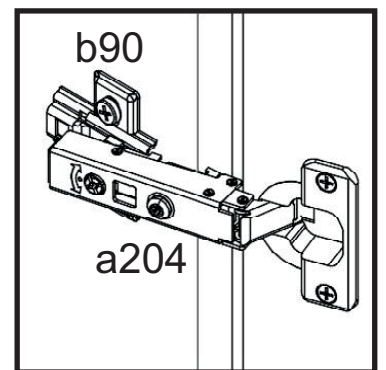
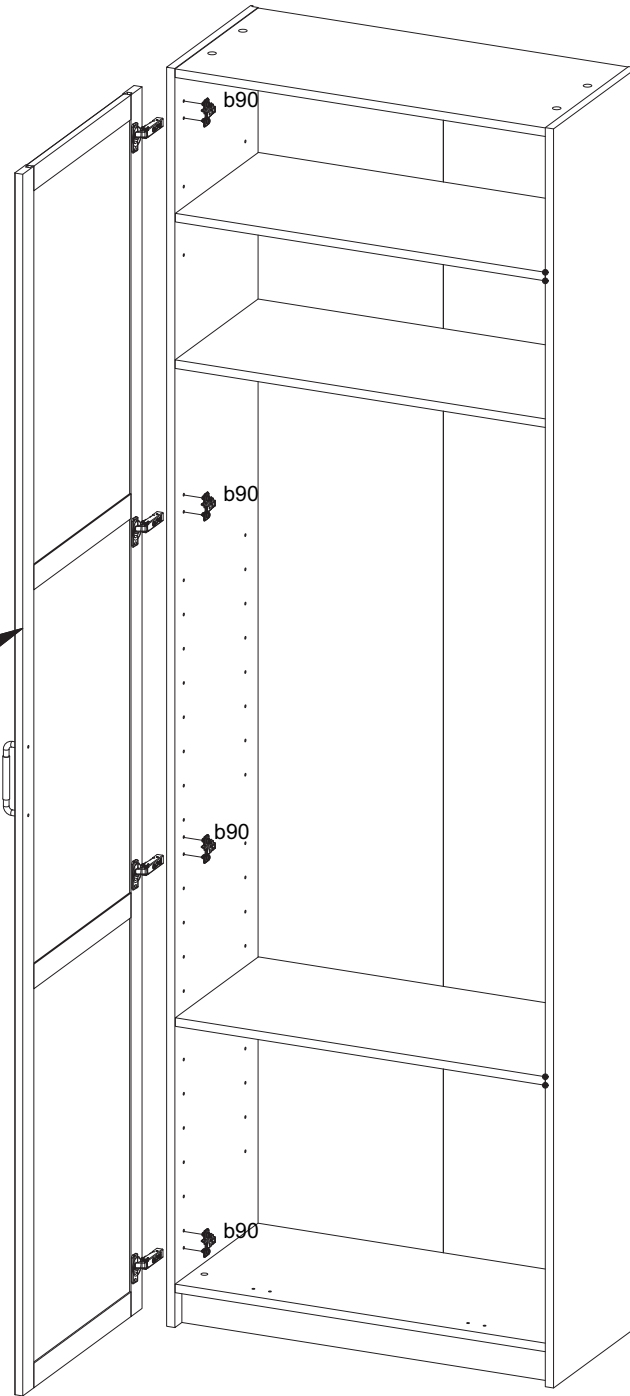

§10

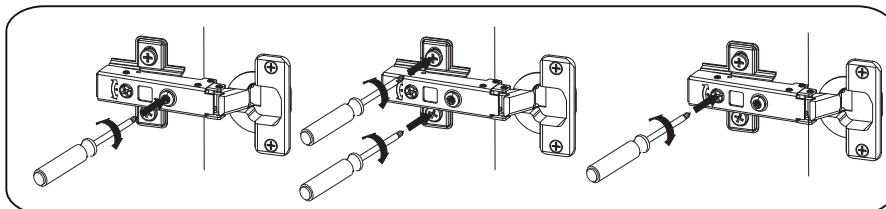

2R

b90 x4

